

Dinplayer mod.D01-MKII USER MANUAL

Warranty

DINplayer has a 24 month warranty on the electronic parts, running from the date of purchase. The warranty will not be valid in case of tampering with the device or in case personnel not authorised by the manufacturer or by the authorised dealer should carry out work on it.

N.B. responsibility of the purchaser: in case of operation under warranty, the device must be packaged so as to prevent damage during transport and shipped to the manufacturer together with all the accessories.

Warranty rules

1. In order to exercise his warranty rights, the purchaser must enclose with the device a copy of evidence of purchase duly stamped by the dealer (bill/invoice).
2. The warranty lasts for 24 months for the electronic parts. The warranty is granted at the point of sale or else directly requested from the manufacturer.
3. The warranty only covers damage to the product which makes it work badly.
4. Work under warranty will only mean repairing or replacing, free of charge, any parts acknowledged to be defective during manufacture or in their material, including labour costs.
5. The warranty does not apply to damage caused by negligence or failure to comply with the instructions, or damage caused by unauthorised people, with a special reference to the outside parts.
6. Also, the warranty does not apply to damage caused to the device by connection to unsuitable power sources.
7. The warranty does not cover parts subject to wear after use, or the container if the material is not defective.
8. The warranty does not include transport costs, which will be paid for by the purchaser in relation to the manner and time of transport.
9. The warranty will run out after 24 months have elapsed. In this case, service will be provided charging for the parts replaced, labour costs and transport according to the current rates.
10. Any dispute will be settled exclusively before the Court of Law of Venice.

TABLE OF CONTENTS

1. [Introduction](#)

- 1.1 [What is DINplayer?](#)
- 1.2 [What is Mp3?](#)
- 1.3 [Encoder](#)
- 1.4 [Decoder](#)
- 1.5 [Player](#)
- 1.6 [Wave](#)
- 1.7 [Audio compression in various formats](#)

2. [Installation](#)

- 2.1 [Content of the DINplayer kit](#)
- 2.2 [Notices](#)

3. [Description and connections](#)

- 3.1 [Command description](#)
- 3.2 [Connection description](#)
- 3.3 [Power supply](#)
- 3.4 [Vplay output for external relay](#)
- 3.5 [DINplayer configurations](#)
- 3.6 [Logical inputs](#)
- 3.7 [Logical inputs: music player](#)

4. [Configuration file](#)

- 4.1 [What is the configuration file?](#)
- 4.2 [Content of the configuration file](#)
- 4.3 [How it is managed by DINplayer](#)
- 4.4 [Preparing the file](#)
- 4.5 [Memorising the files in the Flash memory](#)
- 4.6 [Audio adjustment parameters](#)
- 4.7 [Power amplifier configuration](#)
- 4.8 [Logical inputs configuration](#)
- 4.9 [Playlist/music player configuration](#)
- 4.10 [RS485 serial port communication parameters](#)

5. [Operation with logical inputs](#)

- 5.1 [Introduction to the logical input operation mode](#)
- 5.2 [Binary input command codes](#)

6. [Playlist operation](#)

- 6.1 [Introduction to playlist mode operation – MPLL parameter](#)
- 6.2 [Playlist player](#)
- 6.3 [Playlist player with logic inputs](#)
- 6.4 [Playlist player and RS485](#)

7. Music player mode

- 7.1 [Music player function](#)
- 7.2 [Music player with logical inputs function](#)

8. RS485 serial communication

- 8.1 [DINplayer and RS485](#)
- 8.2 [Serial port communication parameters \(config.txt\)](#)
- 8.3 [Framing error on master](#)
- 8.4 [NAK reply by DINplayer](#)
- 8.5 [Transmitting a command by master](#)
- 8.6 [How to read the figures of the dedicated protocols](#)
- 8.7 [When the Master delivers a command to DINplayer](#)
- 8.8 [Basic format of the dedicated protocols](#)
- 8.9 [Basic set-up of the data transmission](#)
- 8.10 [Control codes](#)
- 8.11 [Address \(ADD\)](#)
- 8.12 [Command \(CMD\)](#)
- 8.13 [CheckSum \(CHK\)](#)
- 8.14 [Basic protocol](#)
- 8.15 [Basic protocol with CheckSum](#)
- 8.16 [Basic protocol with CR and LF](#)
- 8.17 [Basic protocol with CheckSum, CR and LF](#)
- 8.18 [List of commands](#)
- 8.19 [Error codes](#)

9. Specifications

- 9.1 [Technical features](#)
- 9.2 [Obsolete devices disposal](#)

Addendum:

[examples of serial RS485 communication](#)

1

Introduction

1.1 What is DINplayer?

DINplayer is an advanced MP3 player with solid state memory, which has been designed to play warning messages, voice alerts and all types of audio files, recalled by the use of logical inputs in binary combination.

Standard DIN clamp housing allows to use it with different automation systems: PLC, industrial computers, touch screen operated terminals, automatic distributors, commercial promotion systems and various uses on switchboards.

1.2 What is Mp3?

Mp3 is an acronym for Mpeg-1 layer 3. This is an audio compression standard which eliminates sounds which the human ear cannot hear via a psycho-acoustic algorithm. The purpose of this compression is to reduce the space taken up by an audio file while still ensuring excellent quality. The greater the compression, the less the audio quality. The right compromise, which guarantees a quality comparable to that of a Compact Disc, is 128 Kbps (thousands of bits per second) which represents the most widely used manner, and reduces the size of an uncompressed file by 10 times.

1.3 Encoder

Software which compresses audio CDs or wave files into MP3s. There are many software of this kind, and it is virtually impossible to say which is the best.

1.4 Decoder

Software which decompresses an MP3 audio file in order to send it to a digital-analog converter and reconstruct the original audio signal.

1.5 Player



Hardware and software system able to read MP3 audio files. DINplayer is able to carry out this function.

1.6 Wave

High quality audio format (extension .wav), compatible with the tracks of normal music CD's. If one uses a wave file in format 44.1 KHz/sec. at 16 bit in stereo, one will get exactly the same quality as a music CD, but the size of the file is about 10Mb per minute.

1.7 Audio compression in various formats.

The following graphic shows the space taken up by an uncompressed audio file of about 5 minutes (.wav) and compressed in MP3 at 128Kbps (MP3).

Wave		51,1 MB
MP3		4,6 MB

2

Installation

2.1 Content of the kit DINplayer

- n° 1 DINplayer device;
- n° 1 user manual;
- n° 1 flash memory;

2.2 Notices

1. DINplayer has been designed and made to work only with the following mains power supply: 12÷24VDC.
2. The device must be serviced only by qualified staff.
3. Do not put objects inside the device through the openings, in order to prevent the risk of fire or shock.
4. Disconnect the device from the power socket before cleaning. Clean the device using a soft, dry cloth. Do not use liquids or spray which can contain flammable substances.

Obsolete devices disposal :



- When you find this picture on a device, it means that the device is compliant with European Directive 2002/96/EC.
- All electronic and electric devices should be disposed separately from normal garbage.
- The proper disposal of old devices, accessories, and of the batteries in particular, it contributes to prevent possible negative consequences for human health and for the environment.
- For more detailed information on the disposal of obsolete devices, contact the municipality, the garbage disposal service or the shop in which the product has been acquired.

3

Description and connections

3.1 Command description

A -	Flash memory introduction slot for Secure Digital or MultiMedia Card.
B -	<p>Command keys:</p> <ul style="list-style-type: none"> ◀◀ = precedent MP3 file ▶ = (brief pressure) PLAY / (prolonged pressure) increase output volume ■ = (brief pressure) STOP / (prolonged pressure) reduce output volume ▶▶ = next MP3 file <p>⚠ IMPORTANT: - volume control with the keys is active only during the playing of the MP3 file.</p>
C -	Green LED: lit = MP3 file playing; blinking = DINplayer in STOP.
D -	Red LED: lit = device is live.

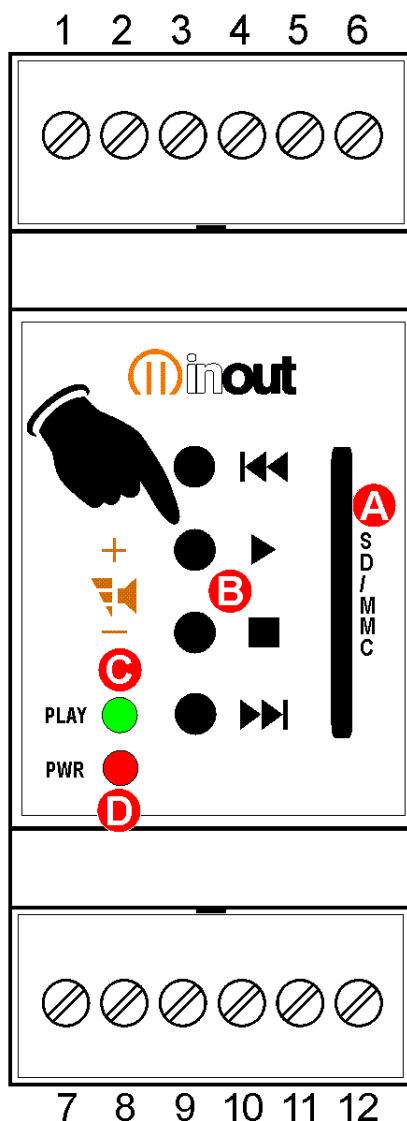

3.2 Connection description

1 -	COM IN	Common inputs (COM INPUT)
2 -	+Vdc	Power supply 12÷24VDC.
3 -	GND	Ground supply / Ground signal of pre-amplified audio output.
4 -	Vplay	Active when device is playing. It supplies the same voltage power of the DINplayer (VDC) and it can directly drive an external relay (150mA max).
5 -	OUT L SPK+	Pre-amplified audio output L channel. Configurable for Amplified 20W audio output for speaker (4Ω min.)
6 -	OUT R SPK-	Pre-amplified audio output R channel. Configurable for Ground signal of amplified audio output.
7 -	IN1	Input for activating 1.mp3 file (direct or bit 0 in binary combination).
8 -	IN2	Input for activating 2.mp3 file (direct or bit 1 in binary combination).
9 -	IN3	Input for activating 4.mp3 file (direct or bit 2 in binary combination).
10 -	IN4	Input for activating 8.mp3 file (direct or bit 3 in binary combination).
11 -	IN5 485A	Input for activating 16.mp3 file (direct or bit 4 in binary combination). Configurable for serial RS485 communication (see chap. 8).
12 -	IN6 485B	Input for activating 32.mp3 file (direct or bit 5 in binary combination). Configurable for serial RS485 communication (see chap. 8).

3.3 Power supply

DINplayer may operate with the following voltage power supplies: 12÷24VDC.

In the case of configuration with power amplifier, the use of a suitable power supply is recommended to supply the required audio power . With a 4Ω loudspeaker, DINplayer can absorb current peaks of 2A.

The standby consumption is 1W.

3.4 Vplay output for external relay

The output of the DINplayer is of a transistor type and is optoisolated towards the inside CPU.

When activated, it provides on the output terminal the same feeding voltage applied on the module. This voltage may be applied to the input of a PLC or else it may directly pilot the spool of an outside relay.

The output can provide a maximum current of 150mA and is equipped with a protection diode for inverse currents induced by the spool of any outside relay.

The output is activated at the time when the reproduction of an audio file starts, and is maintained in this state throughout the duration of the file.

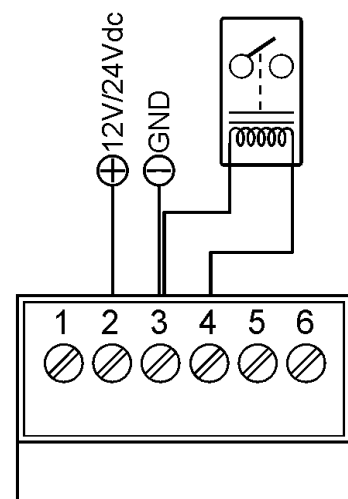

3.5 DINplayer Configurations

DINplayer in addition to the 6 logic inputs for the audio files activation has a mono 20W amplifier to directly drive an external loudspeaker and it can be connected through the serial port to an RS485 bus, to be controlled by a master system or by a computer. To configure the device to meet your needs, gently use a screwdriver to lift the clamps cover and to move the P1, P2, P3, P4 jumpers as displayed below.

1. DINplayer with 6 logical inputs and preamplified STEREO output.

- In the "factory default configuration" the logical inputs mode is active and the power amplifier is NOT active.

IMPORTANT:

- Check if the MOMD parameter is correctly setted (par. 4.7)
 DEFAULT: MOMD=2, power amplifier NOT ACTIVE.

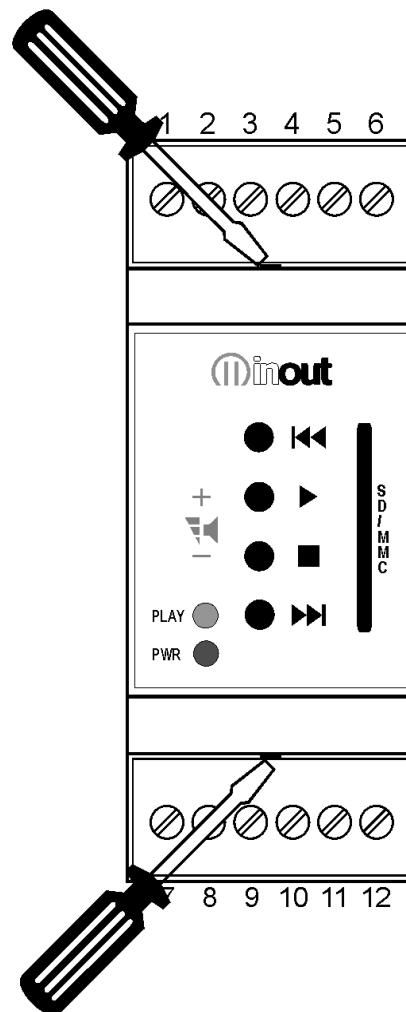
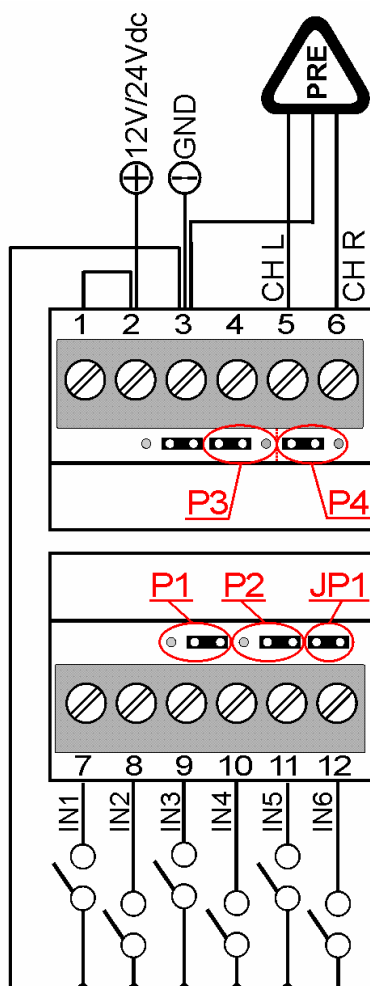

6 logical inputs and preamplified STEREO output (DEFAULT)

2. DINplayer with 6 logical inputs and amplified 20W mono output.

The 20W mono amplifier can directly drive an external loudspeaker with the impedance of 4Ω min. To set the amplified mode, lift the clamps cover and move the jumpers P3 and P4 as in figure.

Attention! Use a loudspeaker with equal or greater power than the one driven by the internal amplifier.

Do not to place the audio connection cables close to the electric power cables to avoid possible troubles.

To set the logical inputs mode, lift the clamps cover with a screwdriver and move the jumpers P1, P2 and JP1 like in figure.

IMPORTANT:

- Check if the MOMD parameter is correctly setted (par. 4.7)
MOMD=0, power amplifier ACTIVE.

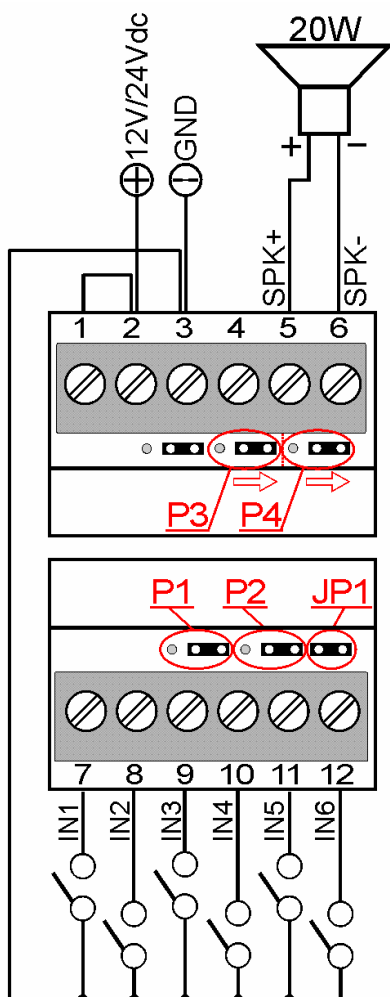

6 logical inputs and amplified MONO output

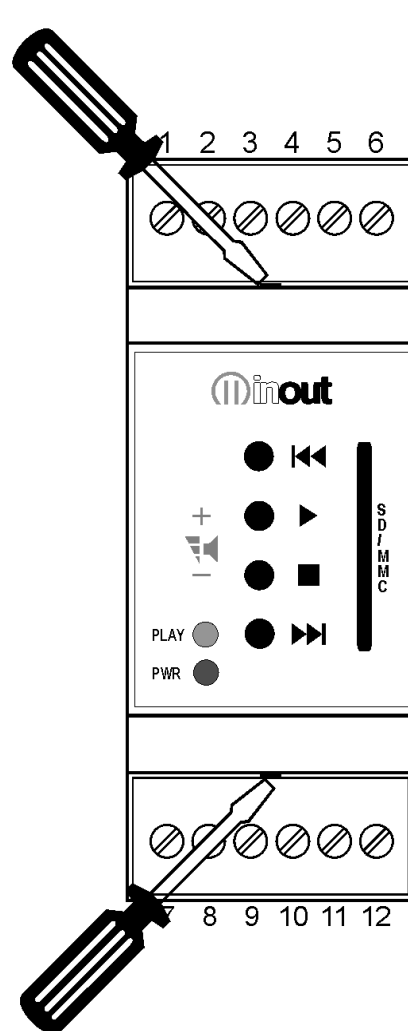

3. DINplayer with RS485 and preamplified STEREO output.

To set the preamplified output mode, lift the clamps cover with a screwdriver and move the jumpers P3 and P4 like in figure.

To enable the serial port through the 11/485A and 12/485B pins, raise the cover of the device and move the **P1** and **P2** jumpers of the diagram as indicated in the following figure.

With the RS485 connection one must supply termination resistors on both extremes of the line, to avoid the generation of stationary waves and to define the impedance of the lines even in absence of transmission. DINplayer already has within itself a termination resistor, enabled through a **JP1** bridge jumper; to activate such resistance it is sufficient to raise the cover of the device and move the **JP1** jumper as indicated in the figure.

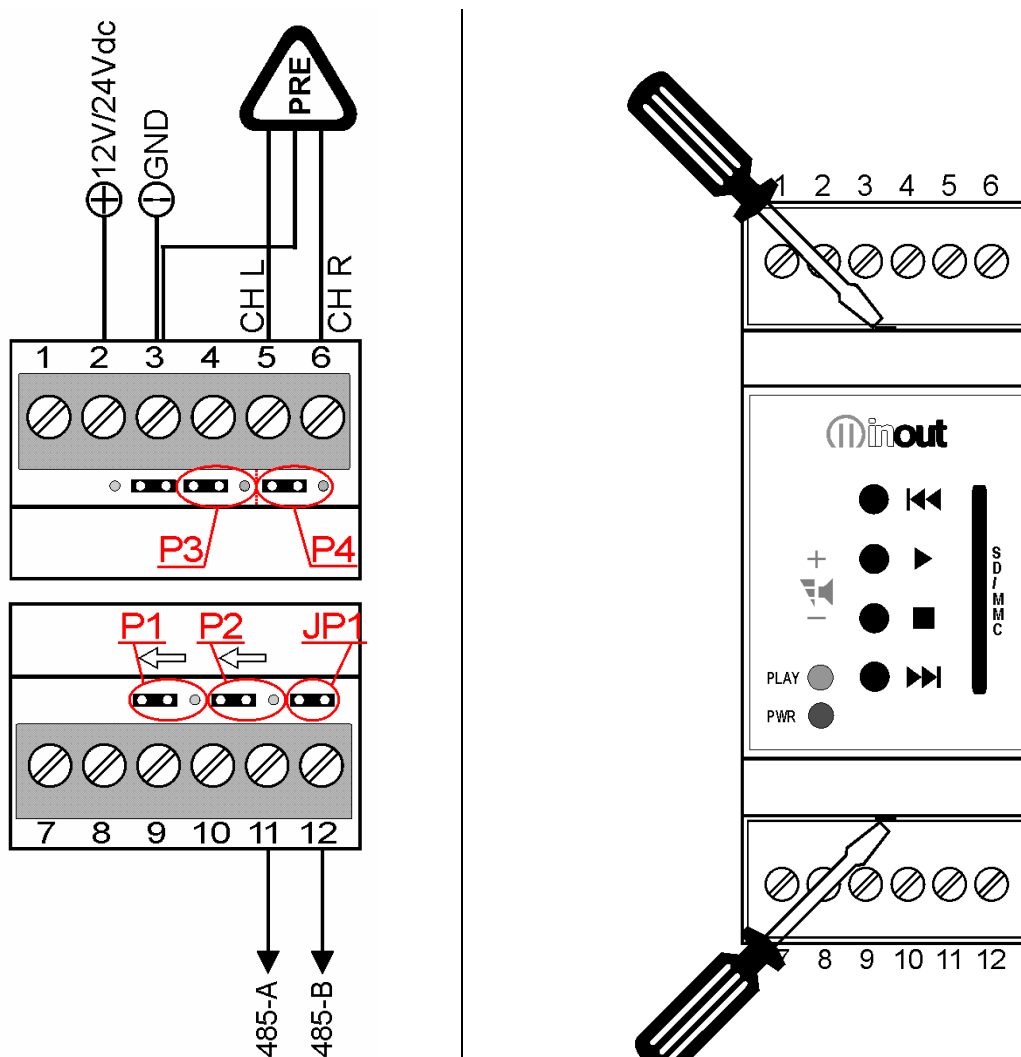

RS485 and preamplified STEREO output

4. DINplayer with RS485 and amplified 20W MONO output.

The 20W mono amplifier can directly drive an external loudspeaker with the impedance of 4Ω min. To set the amplified mode, lift the clamps cover and move the jumpers P3 and P4 like in figure.

Attention! Use a loudspeaker with equal or greater power than the one driven by the internal amplifier. Do not place the audio connection cables close to the electric power cables to avoid possible troubles.

To enable the serial port through the 11/485A and 12/485B pins, raise the cover of the device and move the **P1** and **P2** jumpers of the diagram as indicated in the following figure.

With the RS485 connection one must supply termination resistors on both extremes of the line, to avoid the generation of stationary waves and to define the impedance of the lines even in absence of transmission. DINplayer already has within itself a termination resistor, enabled through a **JP1** bridge jumper; to activate such resistance it is sufficient to raise the cover of the device and move the **JP1** jumper as indicated in the figure.

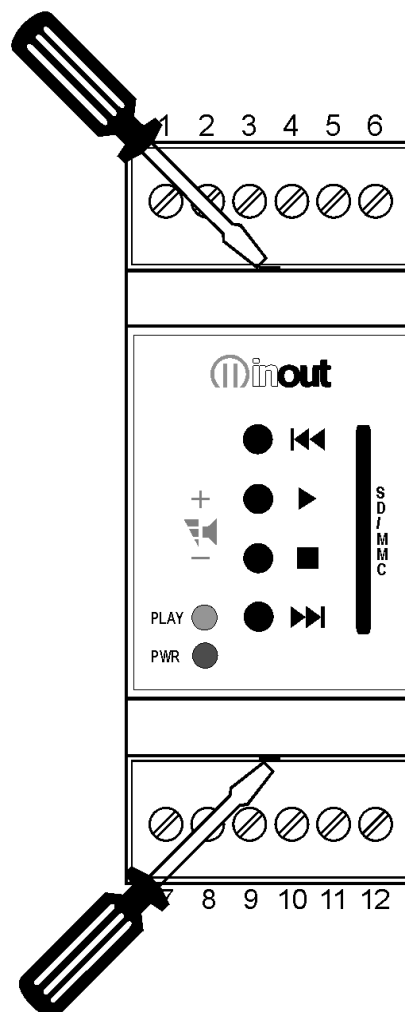
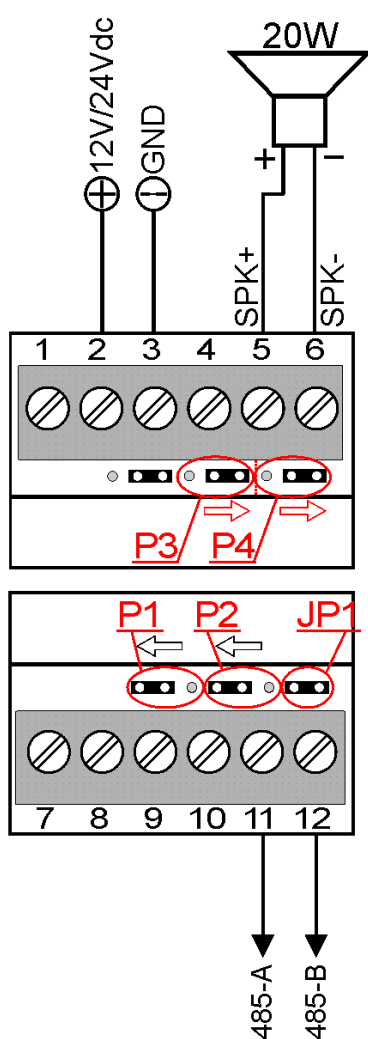

RS485 and amplified MONO output.

3.6 Logical inputs

DINplayer has six optoisolated logical inputs, to trigger the audio files. To activate an input, apply a tension between 12 and 24Vdc to the Common inputs pin and the desired logical input.

Using the binary combination of logical inputs, it is possible to activate a maximum of 63 audio files (see table 5.2).

The positive pole can be indifferently connected to the common inputs or to the logical input.

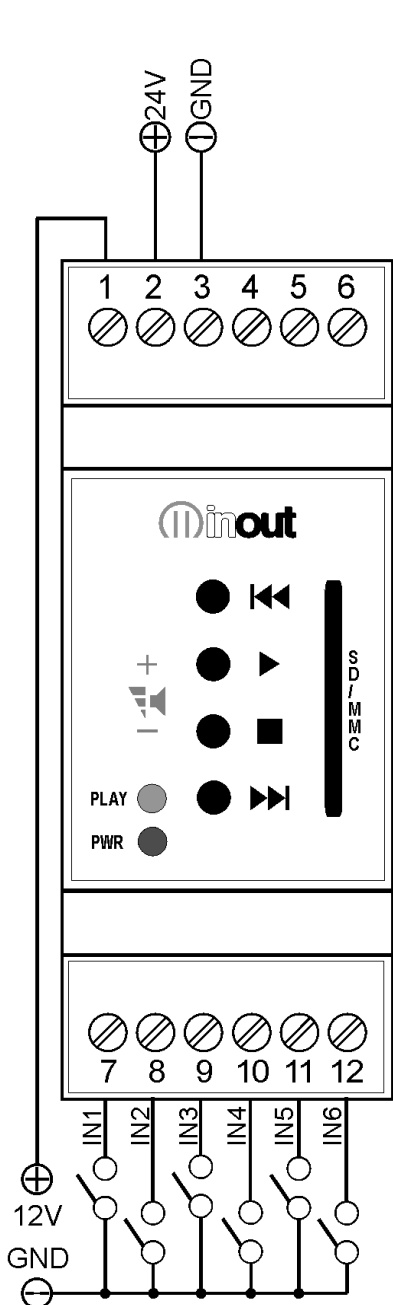

Logical input connected to ground (GND) and external power supply:

connect Common input (pin 1) to a tension between 12 and 24Vdc. To activate the input connect it to power supply ground.

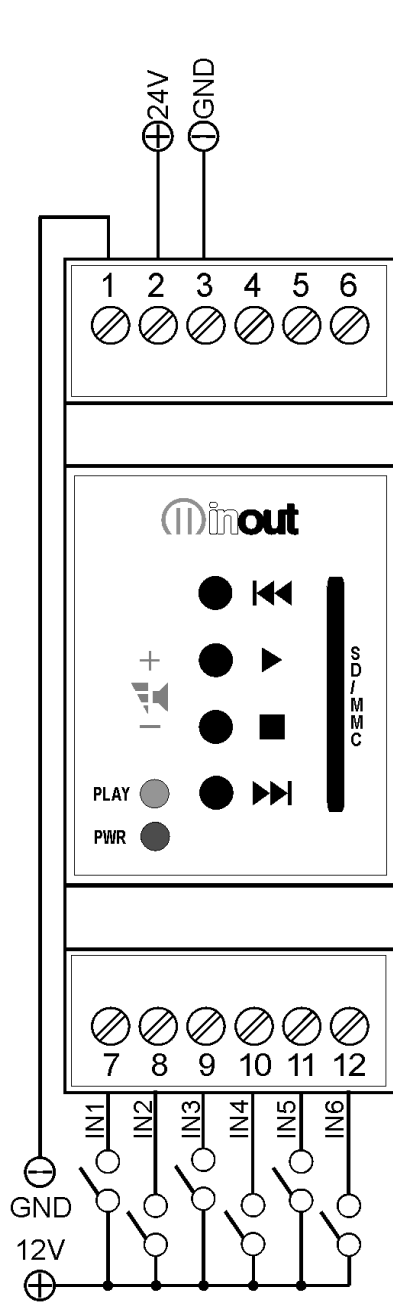

Logical input connected to external power supply (12-24Vdc):

connect Common input (pin 1) to the power supply ground. To activate the input connect it to the power supply positive.

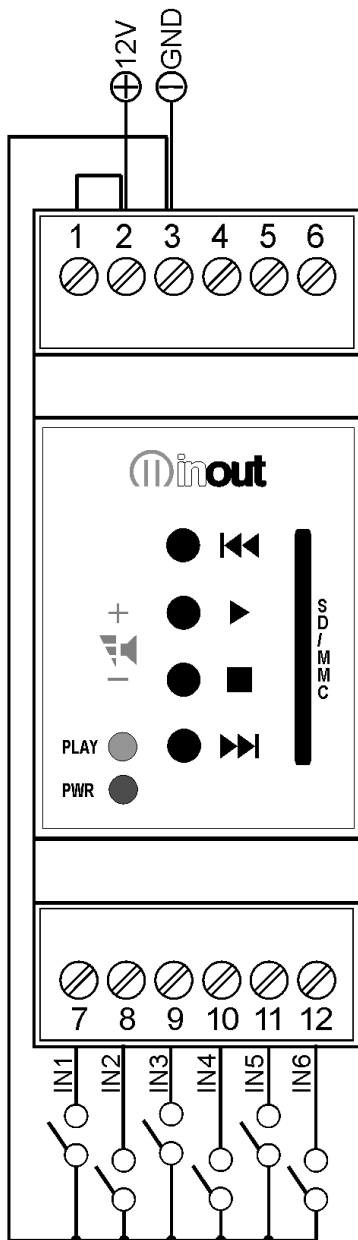

Logical input connected to ground (GND) and internal power supply:

connect the Common input (pin 1) to the DINplayer power supply (12-24Vdc). To activate the input connect it to ground (GND).

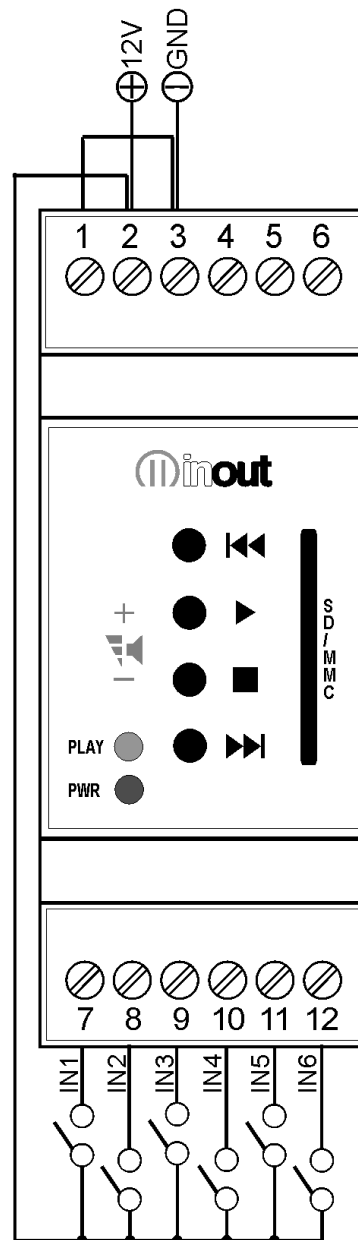

Logical input connected to positive pole and internal power supply:

Connect the Common input (pin1) to the DINplayer power supply ground. To activate the input connect it to the DINplayer power supply positive pole.

3.7 Logical input: music player.

In music player mode (see chapter 7), logical inputs have the typical player functionality, like in the figure.

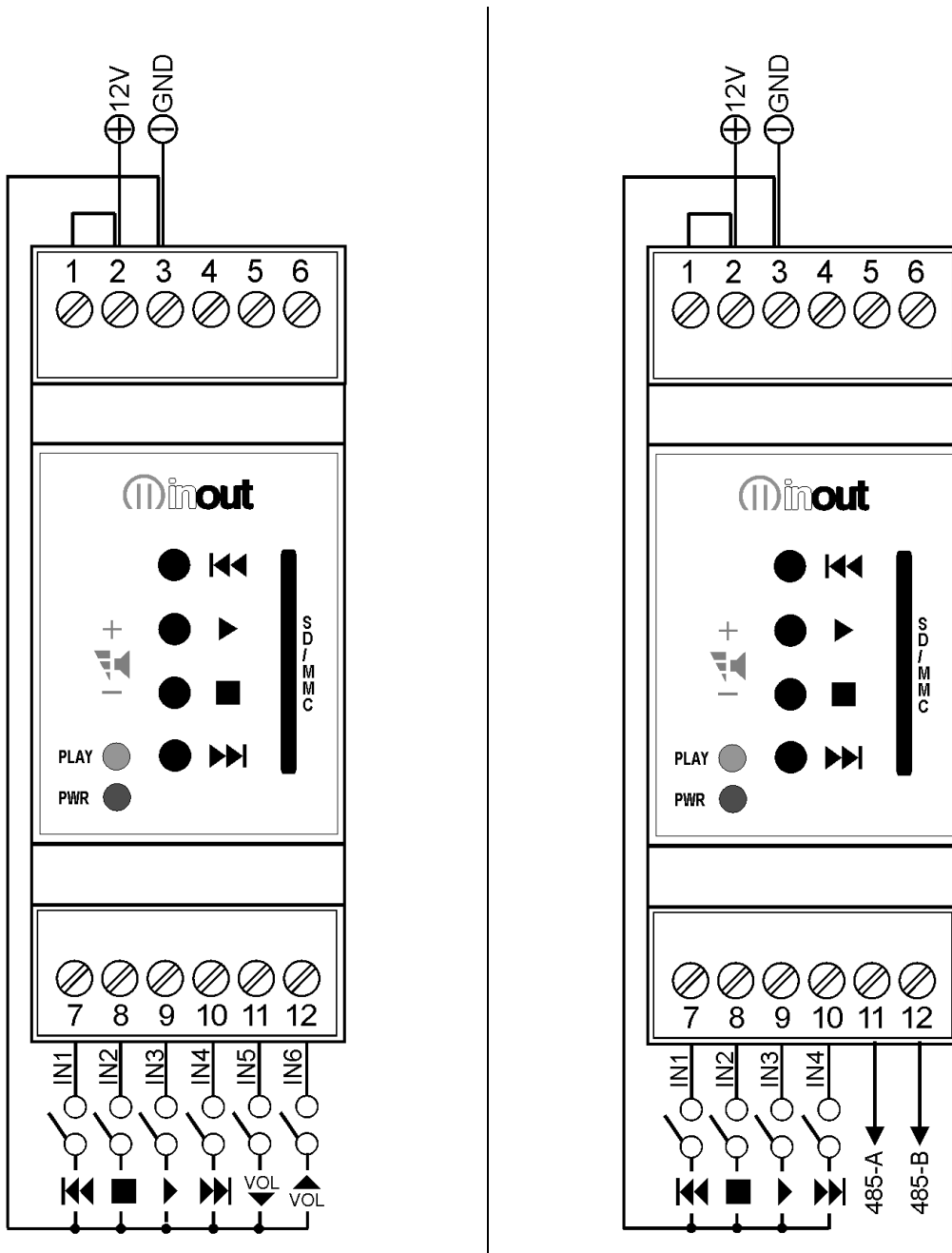

4

Configuration file

4.1 What is the configuration file?

DINplayer is a very versatile device which can be adapted to the needs of the application in which it is used. Different applications may require adjustment of volume, tone, loudness, special parameters of communication or timing. The text file, called 'configuration file' and stored in the main directory of the flash memory, together with the audio files, makes it possible to programme the various parameters of DINplayer.

This file must be assigned the name *config.txt* (this extension has been used so it can be modified by any text editor, including those for portable PocketPC terminals).

4.2 Content of the configuration file

Each line of the configuration file consists of:

- Mnemonic code of the parameter to be set. It always consists of four **CAPITAL** alphanumeric characters, and must always be at the beginning of the line. No more than one parameter is permitted on the same line.
- Separating character. '='. This **MUST** be inserted just after the mnemonic code, without any spacing or tabulation character.
- The relevant numerical parameter expressed as a **decimal**, to be inserted directly after the separation character, without any spacing or tabulation character.

Example file *config.txt*:

LOUT=14	}	Audio adjustment parameters
LLOU=10		
LTRE=14		
LBAS=10		
TPCM=10	}	Logical inputs parameters (direct or binary combinaton)
MICP=1		
MIRS=1		
MPLL=1	}	Playlist/music player mode parameter
MOMD=0	}	Power amplifier on/off parameter
CMAD=0	}	RS485 serial port communication parameters
CMCK=1		
CMCL=0		
CMBR=3		
CMPR=0		
CMSB=1		
CMDB=8		
CMDR=0		
CMNR=0		

4.3 How it is managed by DINplayer

At the time the device is turned on, or when the flash memory is inserted, DINplayer will start to read the main directory of the memory; once it has found the file *config.txt*, it interprets the parameters inserted in each line, memorising them permanently in its internal memory, of a non volatile kind. The parameters therefore stay in memory even after the device has been turned off. This is why it is not indispensable for the configuration file to be always present in the flash memory: once all the parameters have been acquired, this file can also be deleted.

NOTE: If it is necessary to configure various DINplayers with the same parameters, one can prepare a single flash memory with the appropriate *config.txt* file, alternately insert this memory on all the modules to be configured, then insert the memory with the audio files only.

4.4 Preparing the file

To create the file, one can use an ordinary text editor (like Windows Notebook). The file must be saved as a pure text file (.txt). Should other programmes be used (e.g. Microsoft Word) one must be careful to save the document as “**text only**”: otherwise, control characters would be inserted which would make it impossible for DINplayer to interpret this file.

4.5 Memorising the files in the flash memory

The configuration file and all the MP3 audio files can be memorised in the flash memory via a special USB reader/writer for PC.

4.6 Audio adjustment parameters

DINplayer allows for the following audio adjustments:

- adjustments general amplified/pre-amplified output.
- adjustment of loudness level.
- adjustment of high tone level.
- adjustment of low tone level.

The following tables show the relation between the value set in the configuration file and the actual value of the audio parameter.

LOUT (DEFAULT=14) ● general output amplified/pre-amplified level*																					
LOUT=	0	1	2	3	4	5	6	7	8	9	10	11	12	13	14	15	16	17	18	19	20
<i>dB level</i>	OFF	-55	-35	-28	-23	-20	-17	-14	-12	-10	-8	-6	-4	-2	0	+2	+4	+6	+8	+10	+12

* the dB value is always related to the preamplified signal, also with the internal power amplifier activated!

LLOU (DEFAULT=10) ● loudness level																					
LLOU=	0	1	2	3	4	5	6	7	8	9	10	11	12	13	14	15	16	17	18	19	20
<i>dB level</i>	0	+0,5	+1	+1,5	+2	+2,5	+3	+4	+5	+6	+7	+8	+9	+10	+11	+12	+13	+14	+15	+16	+17

LTRE (DEFAULT=14) ● high tone level																					
LTRE=	0	1	2	3	4	5	6	7	8	9	10	11	12	13	14	15	16	17	18	19	20
<i>dB level</i>	-12	-10	-8	-7	-6	-5	-4	-3	-2	-1	0	+1	+2	+3	+4	+5	+6	+7	+8	+10	+12

LBAS (DEFAULT=10) ● low tone level																					
LBAS=	0	1	2	3	4	5	6	7	8	9	10	11	12	13	14	15	16	17	18	19	20
<i>dB level</i>	-12	-10	-8	-7	-6	-5	-4	-3	-2	-1	0	+1	+2	+3	+4	+5	+6	+7	+8	+10	+12

4.7 Power amplifier configuration

In the factory default configuration the power amplifier is NOT active (preamplified configuration). To switch on the power amplifier, set the MOMD parameter in the *config.txt* file.

Mnemonic	Description parameter
MOMD (DEFAULT=2)	Internal amplifier configuration: 0 = Muting ON. The power amplifier is active only during the MP3 files playing. When DINplayer is in STOP mode the power amplifier is in Standby. 1 = Muting OFF. Power Amplifier always active, . Also when DINplayer is in STOP mode. 2 = Power amplifier NOT ACTIVE (default – use this setting in preamplified configuration).

**IMPORTANT:**

- In case of power amplifier excessive high temperature , the thermal protection disables the audio output. To reactivate the amplifier normal operation switch the DINplayer off and then on again.

4.8 Input management parameters

The playing of the files takes place by activating the available logical inputs, the activation modes are set through the TPCM MICP and MIRS parameters inserted in the configuration files.

Mnemonic	Description of timing parameter
TPCM (DEFAULT=10)	Setting the persistence time of the input command (time to wait before DINplayer is able to interpret the input command) expressed in decimals of milliseconds (value between 0 and 255 in decimal). 0 = no delay 1 =10mSeconds 2 =20mSeconds 100 = 1 second 200 = 2 seconds 250 = 2,5 seconds (max. value)
MICP (DEFAULT=1)	Setting Mode Input Continuous Play 0 = having terminated the playing of the codified file, requested from the input code, DINplayer goes in standby. 1 = the requested codified file is continuously played until the relevant input code is inserted.
MIRS (DEFAULT=1)	Setting Mode Input ReStart 0 = repeated activation or deactivating of the same input code does not influence the playing of the relevant file. Only the activation of a different code can block the playing underway and activate the playing of the new requested file. 1 = in the moment in which an input code is enabled the playing of the of the relevant file from its beginning takes place, even if it is already in play.

4.9 Playlist/music player configuration

Mnemonic	Description parameter
MPLL (DEFAULT=1)	0= playlist NOT ACTIVE. 1= playlist ACTIVE. 16= music player mode

4.10 RS485 serial port communication parameters



IMPORTANT:

- The RS485 is active in every configuration.

The following table lists the values of the parameters needed to connect DINplayer to a Master system coordinating it (protocol, speed, timings, etc.).

Mnemonic	Description	
CMAD (DEFAULT=0)	Address DINplayer in the 485 bus (ADD) (Value between 0 and 63 in decimal). IMPORTANT: This address MUST be univocal, two devices with the same address can not co-exist on the same bus.	
CMCK (DEFAULT=1)	Enabling introduction of the Checksum:	0= Checksum deactivated 1= Checksum activated
CMCL (DEFAULT=0)	Enabling introduction of end-of-pack characters CR and LF (hexadecimal values OD and OA)	0= No CR and LF 1= Insertion of CR and LF activated
CMBR (DEFAULT=3)	Baud rate (communication speed in bits per second)	0=1200 bps 1=2400 bps 2=4800 bps 3=9600 bps
CMPR (DEFAULT=0)	Parity Bits:	0= no parity 1= odd parity 2= even parity
CMSB (DEFAULT=1)	Number of Stop Bits	1=1 stopBit 2=2 stopBits
CMDB (DEFAULT=8)	Number of data bits	7=7 bits per datum 8=8 bits per datum
CMDR (DEFAULT=0)	Minimum delay between end of reception of the pack and delivery of the reply. (Value expressed in tenths of msec between 0 and 15 in decimal)	0= Minimum delay of about 4msec 1= Minimum delay of 10msec 2= Minimum delay of 20msec
CMNR (DEFAULT=0)	Deactivate all replies:	0= standard function, every command is followed by a confirmation or error reply. 1= all replies deactivated.

5

Operation with logical inputs (MPLL=0)

5.1 Introduction to the logical input operation mode

DINplayer can also play individual (message) audio files with direct selection from six inputs. Activation is carried out directly or in binary combination, up to a maximum of 255 files, using the inputs IN1, IN2, IN3, IN4, IN5, IN6.

Activating the inputs in binary combination, one can launch the playing of a maximum of 63 messages, naming the audio files as shown on the table.

Player modalities are set with the following parameters:

Example file *config.txt*:

LLOU=10	}	Audio adjustment parameters
LTRE=14		
LBAS=10		
MOMD=0	}	Power amplifier mode
MPLL=0	}	Playlist mode
TPCM=10	}	Logical inputs in binary combination parameters.
MICP=1		
MIRS=0		

Mnemonic	Description of timing parameter
TPCM (DEFAULT=10)	Setting the persistence time of the input command (time to wait before DINplayer is able to interpret the input command) expressed in decimals of milliseconds (value between 0 and 255 in decimal). 0 = no delay 1 = 10mSeconds 2 = 20mSeconds 100 = 1 second 200 = 2 seconds 250 = 2,5 seconds (max. value)
MICP (DEFAULT=1)	Setting Mode Input Continuous Play 0 = having terminated the playing of the codified file, requested from the input code, DINplayer goes in standby. 1 = the requested codified file is continuously played until the relevant input code is inserted.
MIRS (DEFAULT=1)	Setting Mode Input ReStart 0 = repeated activation or deactivating of the same input code does not influence the playing of the relevant file. Only the activation of a different code can block the playing underway and activate the playing of the new requested file. 1 = in the moment in which an input code is enabled the playing of the of the relevant file from its beginning takes place, even if it is already in play.



IMPORTANT:

- volume control with the keys is active only during the playing of the MP3 file.

5.2 Binary input command codes

Activating the inputs in binary combination, one can launch the playing of a maximum of 63 messages, naming the audio files as shown on the following table.

INPUT						FILE	INPUTS BINARY COMBINATION	
1	2	3	4	5	6	(.mp3)		
0	0	0	0	0	0	=	stand by	
1	0	0	0	0	0	=	1	individual activation input IN 1
0	1	0	0	0	0	=	2	individual activation input IN 2
1	1	0	0	0	0	=	3	binary combination inputs IN 1 + IN 2
0	0	1	0	0	0	=	4	individual activation input IN 3
1	0	1	0	0	0	=	5	binary combination inputs IN 1 + IN 3
0	1	1	0	0	0	=	6	binary combination inputs IN 2 + IN 3
1	1	1	0	0	0	=	7	binary combination inputs IN 1 + IN 2 + IN 3
0	0	0	1	0	0	=	8	individual activation input IN 4
1	0	0	1	0	0	=	9	binary combination inputs IN 1 + IN 4
0	1	0	1	0	0	=	10	binary combination inputs IN 2 + IN 4
1	1	0	1	0	0	=	11	binary combination inputs IN 1 + IN 2 + IN 4
0	0	1	1	0	0	=	12	binary combination inputs IN 3 + IN 4
1	0	1	1	0	0	=	13	binary combination inputs IN 1 + IN 3 + IN 4
0	1	1	1	0	0	=	14	binary combination inputs IN 2 + IN 3 + IN 4
1	1	1	1	0	0	=	15	binary combination inputs IN 1 + IN 2 + IN 3 + IN 4
0	0	0	0	1	0	=	16	individual activation input IN 5
1	0	0	0	1	0	=	17	binary combination inputs IN 1 + IN 5
0	1	0	0	1	0	=	18	binary combination inputs IN 2 + IN 5
1	1	0	0	1	0	=	19	binary combination inputs IN 1 + IN 2 + IN 5
0	0	1	0	1	0	=	20	binary combination inputs IN 3 + IN 5
1	0	1	0	1	0	=	21	binary combination inputs IN 1 + IN 3 + IN 5
0	1	1	0	1	0	=	22	binary combination inputs IN 2 + IN 3 + IN 5
1	1	1	0	1	0	=	23	binary combination inputs IN 1 + IN 2 + IN 3 + IN 5
0	0	0	1	1	0	=	24	binary combination inputs IN 4+ IN 5
1	0	0	1	1	0	=	25	binary combination inputs IN 1 + IN 4 + IN 5
0	1	0	1	1	0	=	26	binary combination inputs IN 2 + IN 4 + IN 5
1	1	0	1	1	0	=	27	binary combination inputs IN 1 + IN 2 + IN 4 + IN 5
0	0	1	1	1	0	=	28	binary combination inputs IN 3 + IN 4 + IN 5
1	0	1	1	1	0	=	29	binary combination inputs IN 1 + IN 3 + IN 4 + IN 5
0	1	1	1	1	0	=	30	binary combination inputs IN 2 + IN 3 + IN 4 + IN 5
1	1	1	1	1	0	=	31	binary combination inputs IN 1 + IN 2 + IN 3 + IN 4 + IN 5
0	0	0	0	0	1	=	32	individual activation input IN 6
1	0	0	0	0	1	=	33	binary combination inputs IN 1 + IN 6
0	1	0	0	0	1	=	34	binary combination inputs IN 2 + IN 6
1	1	0	0	0	1	=	35	binary combination inputs IN 1 + IN 2 + IN 6
0	0	1	0	0	1	=	36	binary combination inputs IN 3 + IN 6
1	0	1	0	0	1	=	37	binary combination inputs IN 1 + IN 3 + IN 6
0	1	1	0	0	1	=	38	binary combination inputs IN 2 + IN 3 + IN 6
1	1	1	0	0	1	=	39	binary combination inputs IN 1 + IN 2 + IN 3 + IN 6
0	0	0	1	0	1	=	40	binary combination inputs IN 4 + IN 6

INPUT						FILE	INPUT'S BINARY COMBINATION
1	2	3	4	5	6	(.mp3)	
1	0	0	1	0	1	= 41	binary combination inputs IN 1 + IN 4 + IN 6
0	1	0	1	0	1	= 42	binary combination inputs IN 2 + IN 4 + IN 6
1	1	0	1	0	1	= 43	binary combination inputs IN 1 + IN 2 + IN 4 + IN 6
0	0	1	1	0	1	= 44	binary combination inputs IN 3 + IN 4 + IN 6
1	0	1	1	0	1	= 45	binary combination inputs IN 1 + IN 3 + IN 4 + IN 6
0	1	1	1	0	1	= 46	binary combination inputs IN 2 + IN 3 + IN 4 + IN 6
1	1	1	1	0	1	= 47	binary combination inputs IN 1 + IN 2 + IN 3 + IN 4 + IN 6
0	0	0	0	1	1	= 48	binary combination inputs IN 5 + IN 6
1	0	0	0	1	1	= 49	binary combination inputs IN 1 + IN 5 + IN 6
0	1	0	0	1	1	= 50	binary combination inputs IN 2 + IN 5 + IN 6
1	1	0	0	1	1	= 51	binary combination inputs IN 1 + IN 2 + IN 5 + IN 6
0	0	1	0	1	1	= 52	binary combination inputs IN 3 + IN 5 + IN 6
1	0	1	0	1	1	= 53	binary combination inputs IN 1 + IN 3 + IN 5 + IN 6
0	1	1	0	1	1	= 54	binary combination inputs IN 2 + IN 3 + IN 5 + IN 6
1	1	1	0	1	1	= 55	binary combination inputs IN 1 + IN 2 + IN 3 + IN 5 + IN 6
0	0	0	1	1	1	= 56	binary combination inputs IN 4 + IN 5 + IN 6
1	0	0	1	1	1	= 57	binary combination inputs IN 1 + IN 4 + IN 5 + IN 6
0	1	0	1	1	1	= 58	binary combination inputs IN 2 + IN 4 + IN 5 + IN 6
1	1	0	1	1	1	= 59	binary combination inputs IN 1 + IN 2 + IN 4 + IN 5 + IN 6
0	0	1	1	1	1	= 60	binary combination inputs IN 3 + IN 4 + IN 5 + IN 6
1	0	1	1	1	1	= 61	binary combination inputs IN 1 + IN 3 + IN 4 + IN 5 + IN 6
0	1	1	1	1	1	= 62	binary combination inputs IN 2 + IN 3 + IN 4 + IN 5 + IN 6
1	1	1	1	1	1	= 63	binary combination inputs IN 1 + IN 2 + IN 3 + IN 4 + IN 5 + IN 6

6

Playlist operation

6.1 Introduction to playlist mode operation (MPLL=1).

DINplayer is able to follow a sequence or list of music pieces; this play list is a simple text file called *playlist.txt* which can be inserted in the main directory of the same memory containing the audio files (this extension is used so it can be modified via a handy PocketPC portable terminal).

Use the MPLL (Mode PLaYList) parameter to set this mode.

Mnemonic	Parameter description
MPLL (DEFAULT=1)	Playlist mode configuration 0=Playlist NOT ACTIVE 1=Playlist ACTIVE

6.2 Playlist player

Follow a few, easy rules to set the sequence:

Example: playlist with 10 mp3 files:

```
Intro
Rock1
Jazz2065
Sinatra
Alarm626
Warning4
Sugar
Relax01
NewAge10
Easy23
```



IMPORTANT:

- **Rename the MP3 audio files with numbers or names with max. 8 characters.**
- **Do not write in the extension (.mp3**
- **Max. 500 pieces per playlist**

Fit the memory into its seat and wait for DINplayer to read the playlist in order to check the list of pieces contained.

At the end of the reading operation, if the names of the pieces have been fitted in correctly, DINplayer will automatically start to play the musical items in the programmed sequence.

The 4 keys in the front panel, work as follows:

⏮ = precedent MP3 file

▶ = (brief pressure) PLAY / (prolonged pressure) increase output volume

■ = (brief pressure) STOP / (prolonged pressure) reduce output volume

⏭ = next MP3 file

Example file *config.txt*:

LLOU=10	}	Audio adjustment parameters
LTRE=14		
LBAS=10		
MOMD=0	}	Power amplifier parameter
MPLL=1	}	Playlist mode parameter

IMPORTANT:

- volume control with the keys is active only during the playing of the MP3 file.
- Pressing STOP during playlist reproduction, DINplayer stops the sequence reproduction. Then, when PLAY is pressed, the playlist is reactivated playing the interrupted file from the beginning.

6.3 Playlist player with logical inputs (MPLL=1)

The logical inputs work also in playlist mode. If a logical input is activated during playlist playing, DINplayer acts as follows:

1. Playlist is SOPPED and the file corresponding to the logical input is played
2. RESTART playlist from the file following the interrupted one.

Example file *config.txt*:

LLOU=10	}	Audio adjustment parameters
LTRE=14		
LBAS=10		
MOMD=0	}	Power amplifier parameter
MPLL=1	}	Playlist mode parameter
TPCM=10	}	Logical inputs in binary combination parameters.
MICP=1		
MIRS=1		

IMPORTANT:

- For this mode set MIRS=1.
- volume control with the keys is active only during the playing of the MP3 file.
- Pressing STOP during playlist reproduction, DINplayer stops the sequence reproduction. Then, when PLAY is pressed, the playlist is reactivated playing the interrupted file from the beginning.

6.4 Playlist player and RS485

The RS485 functionality is always active, also in playlist mode.

If a RS485 command is sent during playlist reproduction, DINplayer acts as follows:

1. Playlist is SOPPED and the file corresponding to the RS485 command is played
2. RESTART playlist from the file following the interrupted one.

Example file *config.txt*:

LLOU=10	}	Audio adjustment parameters
LTRE=14		
LBAS=10		
MOMD=0	}	Power amplifier parameter
MPLL=1	}	Playlist mode parameter
CMAD=0	}	RS485 serial port communication parameters
CMCK=1		
CMCL=0		
CMBR=3		
CMPR=0		
CMSB=1		
CMDB=8		
CMDR=0		
CMNR=0		

IMPORTANT:

- volume control with the keys is active only during the playing of the MP3 file.
- Pressing STOP during playlist reproduction, DINplayer stops the sequence reproduction. Then, when PLAY is pressed, the playlist is reactivated playing the interrupted file from the beginning

7

Music Player mode (MPLL=16)**7.1 Music Player function (MPLL=16)**

DINplayer works just like a standard player in this mode and does not require any specific programming (or playlist file). Any MP3 file can be played, even with long names.

Use the MPLL (Mode PlasList) parameter to set this mode (in config.txt).

Example file *config.txt*:

LLOU=10	}	Audio adjustment parameters
LTRE=14		
LBAS=10		
MOMD=0	}	Power amplifier parameter
MPLL=16	}	Music player mode parameter

 IMPORTANT:

- volume control with the keys is active only during the playing of the MP3 file.
- When the Stop button is pressed, DINplayer memorises the track currently being played; press Play and DINplayer will play the track from the beginning. This function enables very long file sequences in large flash memories to be played, without having to re-listen to the entire sequence from the first track.
If you wish to listen to the entire sequence again starting from the first track, just remove the flash memory or turn the DINplayer off and on again.

The tracks will be played in the sequence in which they are memorised in the flash memory; if a block of data is transferred then the written sequence in the flash memory will depend on the operating system used; if a precise sequence is preferred, then we recommend transferring one MP3 file at a time.

In this mode, DINplayer will automatically start to play the audio file, starting from the first track, when the device is switched on or when the flash memory is inserted; the user can run through the files just like listening to an audio CD by using the buttons on the front of the device or by activating the commands with logical inputs, as in the following table:

The 4 keys in the front panel, work as follows:

⏪ = precedent MP3 file

▶ = (brief pressure) PLAY / (prolonged pressure) increase output volume

■ = (brief pressure) STOP / (prolonged pressure) reduce output volume

⏩ = next MP3 file

7.2 Music player with logical inputs function

In music player mode, the logical inputs can be used for player control.

◀◀ = previous MP3 file

■ = stops file reproduction.

▶ = DINplayer restarts from the beginning of the interrupted file

▶▶ = next MP3 file

^{VOL}▼ = reduce output volume, (press repeatedly)

^{VOL}▲ = increase output volume, (press repeatedly)

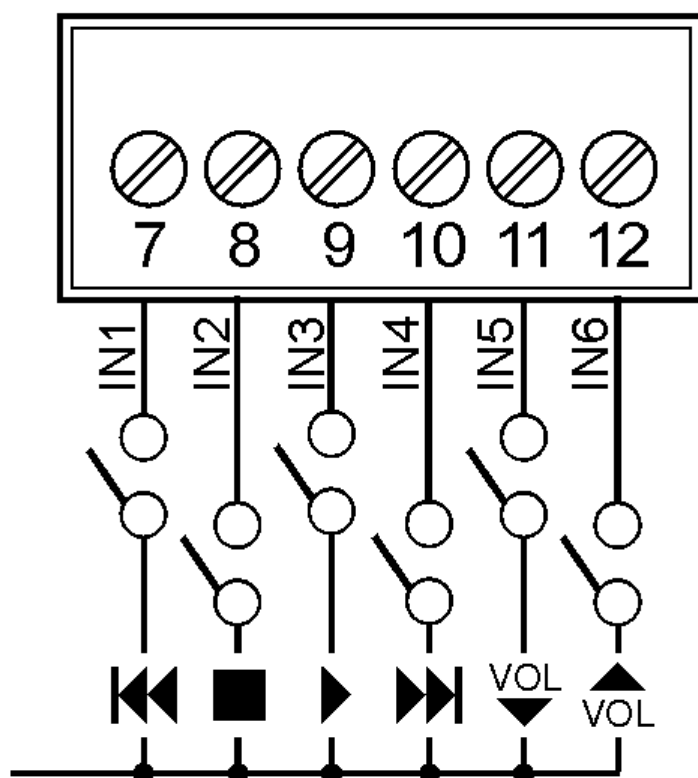

8

Serial RS485 communication



IMPORTANT:

- The RS485 is active in every configuration.

DINplayer can be connected to an RS485 communication bus through a serial port, which is controlled from a master system or by a computer.

Due to interference from outside the serial line, one may find anomalous behaviour from part of the master system which could cause possible damage to DINplayer. To avoid this mishap one must take the following precautions:

1. Do not let the serial cables transit in the same conduits as power cables or cables with elevated voltage. Maintain a safety distance of at least 10 cm. between these cables.
2. Connect serial cable screen to the ground the on one of the two sides (do not connect the screen from both sides); in addition, the ground connection of the screen must not be made in the same point in which piloted circuits of elevated tension are connected.
3. Cut the voltage of the entire system before beginning the wiring of the serial lines: even dispersed or parasite currents could damage the modules.

DINplayer withstands serial communication in 4 different modes with the RS485 electrical standard. This type of serial multipoint communication consents the connection in bus of up to 32 devices, with a maximum distance of 50 metres.

The DINplayer devices connected to the RS485 bus can not autonomously begin communication, but they can only respond to a specific request (command) from the master station (usually a PLC or a computer).

The RS485 connection parameters (speed, parity, check-sum, etc.) are set via the configuration file *config.txt*.



IMPORTANT:

- The internal electronics of DINplayer are not galvanically insulated from the RS485 line; in case of short circuit or discharge to ground, it is possible to damage not only the DINplayer, but even the master system to which it is connected!
- For the RS485 connection, one must remember to ignore the transmission echo from the master that is returning through the serial line.

8.1 DINplayer and RS485

To enable the serial port through the 11/485A and 12/485B pins, raise the cover of the device and move the **P1** and **P2** jumpers of the diagram as indicated in the following figure.

With the RS485 connection one must supply termination resistors on both extremes of the line, to avoid the generation of stationary waves and to define the impedance of the lines even in absence of transmission. DINplayer already has within itself a termination resistor, enabled through a **JP1** bridge jumper; to enable such resistance it is sufficient to raise the cover of the device and move the **JP1** jumper as indicated in the figure.

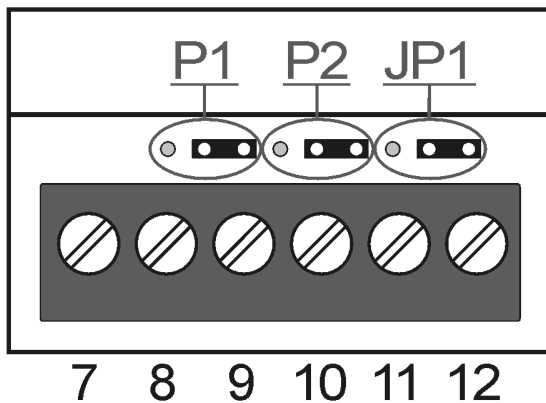
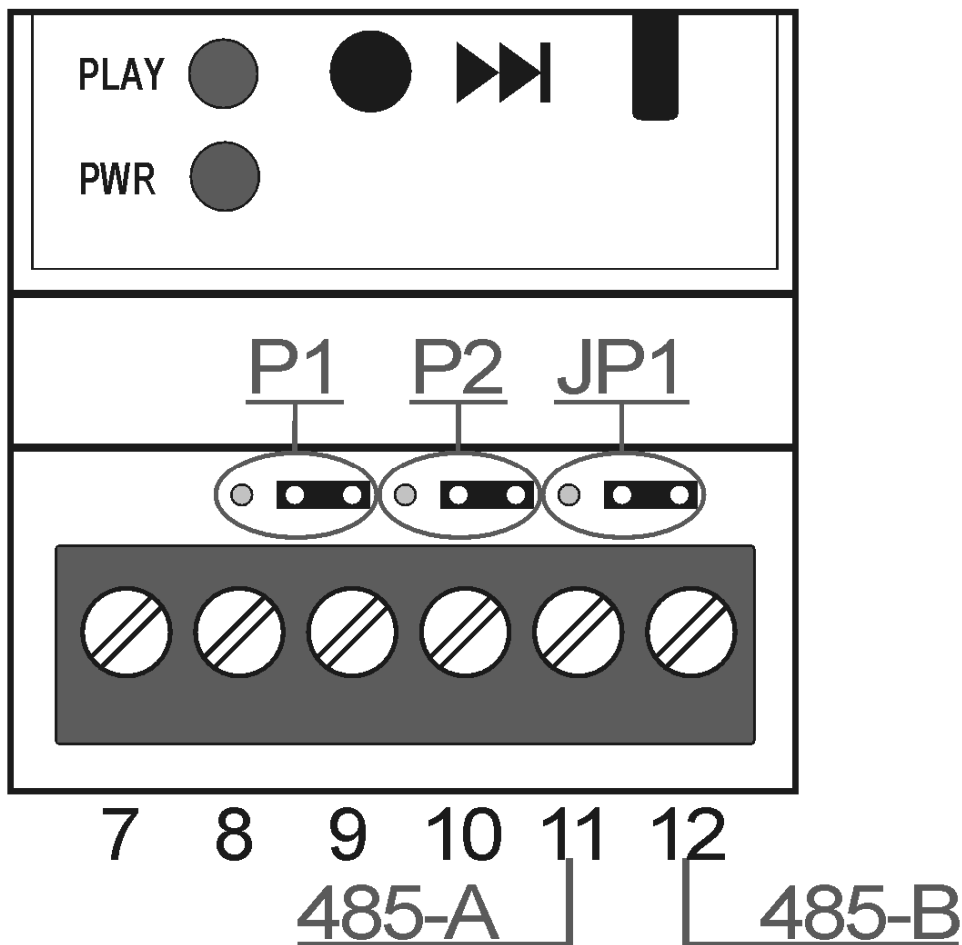

P1 and P2 position (Default):

- P1 set PIN 11 as logical input (IN5)
- P2 set PIN 12 as logical input (IN6)

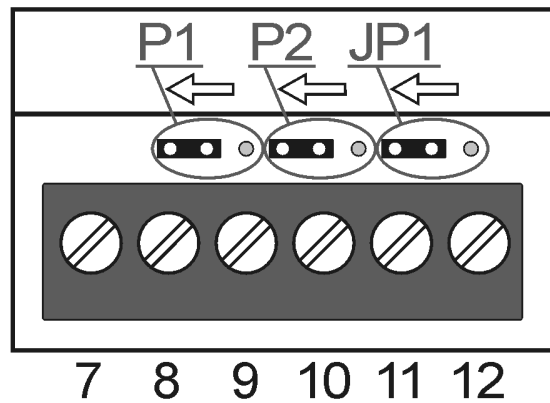

P1, P2 and JP1 position in RS485 mode:

- P1 set PIN 11 as RS485A
- P2 set PIN 12 as RS485B
- JP1 sets RS485 termination's resistor (120Ω).

8.2 Serial port communication parameters (config.txt)

The parameters of the RS485 serial port (length of the packs, parity, speed, etc.) are set via the configuration file *config.txt*.

Example file *config.txt*:

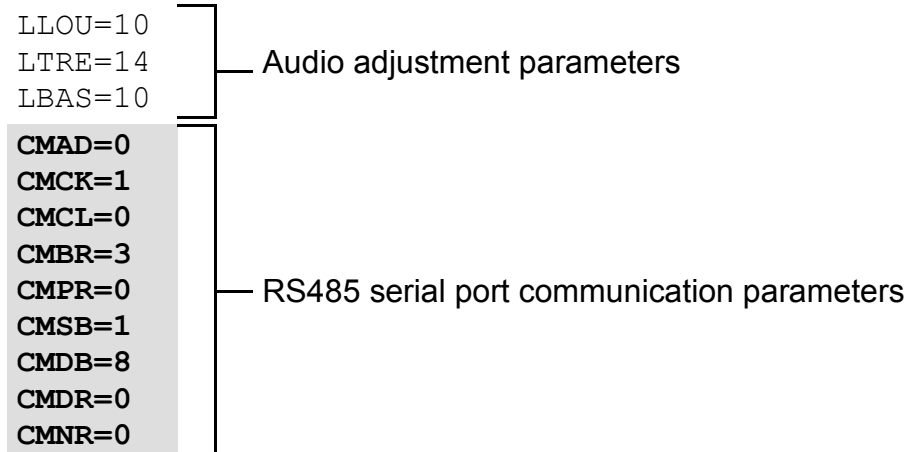

These parameters must coincide with those of the outside device with which DINplayer is to communicate.



IMPORTANT:

- To make the modification of these parameters effective, it is necessary to restart DINplayer after having introduced the flash memory with the file *config.txt*.
- If DINplayer is not used with Playlist or as music player, set MPLL=0 in the *config.txt*.



IMPORTANT: notes for the Master system

Conditions in which a transmission sequence is initialised.

The DINplayer transmission sequence is initialised under the following conditions:

- When DINplayer is turned on.
- When the data communication has been normally completed.
- When the timeout time for receiving a pack has expired.

The following table lists the values of the parameters needed to connect DINplayer to a Master system coordinating it (protocol, speed, timings, etc.).

Mnemonic	Description	
CMAD (DEFAULT=0)	Address DINplayer in the 485 bus (ADD) (Value between 0 and 63 in decimal).  IMPORTANT: This address MUST be univocal, two devices with the same address can not co-exist on the same bus.	
CMCK (DEFAULT=1)	Enabling introduction of the Checksum:	0= Checksum deactivated 1= Checksum activated
CMCL (DEFAULT=0)	Enabling introduction of end-of-pack characters CR and LF (hexadecimal values OD and OA)	0= No CR and LF 1= Insertion of CR and LF activated
CMBR (DEFAULT=3)	Baud rate (communication speed in bits per second)	0=1200 bps 1=2400 bps 2=4800 bps 3=9600 bps
CMPR (DEFAULT=0)	Parity Bits:	0= no parity 1= odd parity 2= even parity
CMSB (DEFAULT=1)	Number of Stop Bits	1=1 stopBit 2=2 stopBits
CMDB (DEFAULT=8)	Number of data bits	7=7 bits per datum 8=8 bits per datum
CMDR (DEFAULT=0)	Minimum delay between end of reception of the pack and delivery of the reply. (Value expressed in tenths of msec between 0 and 15 in decimal)	0= Minimum delay of about 4msec 1= Minimum delay of 10msec 2= Minimum delay of 20msec
CMNR (DEFAULT=0)	Deactivate all replies:	0= standard function, every command is followed by a confirmation or error reply. 1= all replies deactivated.

Message waiting time (CMDR)

This is the delay time of the reply message, required by some computers to switch over between the state of transmission and the state of reception.

The awaiting time determines the minimum delay before the DINplayer sends data in reply to the message received from the Master. Set this time at a value different from **0** only if the specifications of the Master demand it, since the delay determines an extension of the time needed to complete the command.

8.3 " Framing" error on the master

When commercial RS-485 interfaces are used on the master, a Framing error may take place if nothing is being transmitted on the serial line.

In order to avoid this mishap, it is indispensable that the system master ignores all the data until it has received one of the **STX**, **ACK** or **NAK** characters coming from a DINplayer.

8.4 NAK reply by DINplayer

The reply with the character **NAK** is sent from DINplayer to the master when any kind of error is detected in the message received.

8.5 Transmitting a command by master

When you send a command from the master to DINplayer using one of the dedicated protocols, make sure you send it with a delay of at least 10mS starting from the moment the last command received by DINplayer has been completely performed.



IMPORTANT:

when one is using the RS485 bus (only on a duplex cable) remember to bear in mind or to ignore the echo of the command that is sent from the master (with RS485 an echo is always present).

8.6 How to read the figures of the dedicated protocols

When the master reads the data from DINplayer.

(DINplayer > Master)

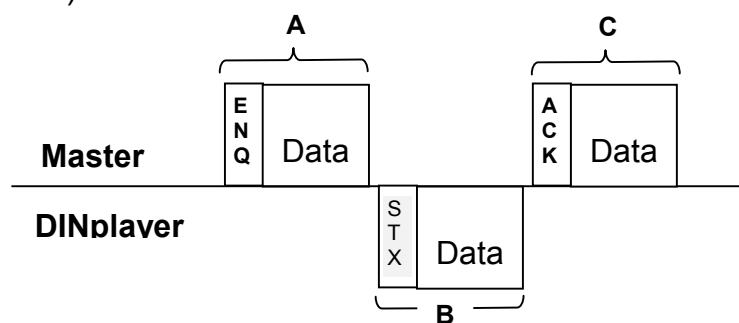

- The data areas **A** and **C** indicate the transmission of data from the master to DINplayer.
- The data area **B** indicates the transmission of data from DINplayer to the master.
- The programme of the Master is structured so as to manage the data in the manner shown on the figure from left to right. Therefore, the data management sequence is **A, B, C**.
Example : In area **A**, the character **ENQ** (05H) is transmitted, followed by all the other data indicated as " **Data**" in the figure to the right of the character **ENQ**.

8.7 When the Master delivers a command to DINplayer

(Master > DINplayer)

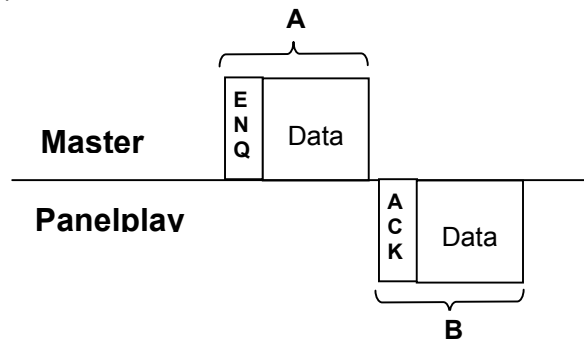

- The data area **A** indicates the transmission of data from the master to DINplayer.
 - The data area **B** indicates the transmission of data from DINplayer to the master.
 - The programme of the master is structured so as to manage the data in the manner shown on the figure from left to right. Therefore, the data management sequence is **A, B**.
- Example :** In area **A**, the character **ENQ** (05H) is transmitted, followed by all the other data indicated as " **Data**" in the figure to the right of the character **ENQ**.

8.8 Basic format of the dedicated protocols

DINplayer manages up to four dedicated protocols.

The definition of which of these four protocols must be used by the serial connection, is set in the configuration file *config.txt*. (par. 9.2).

The difference among these four formats is due to the presence or absence of CheckSum and/or of the characters **CR** (Carriage Return, character **0DH**) and **LF** (Line Feed, character **0AH**).

8.9 Basic set-up of the data transmission

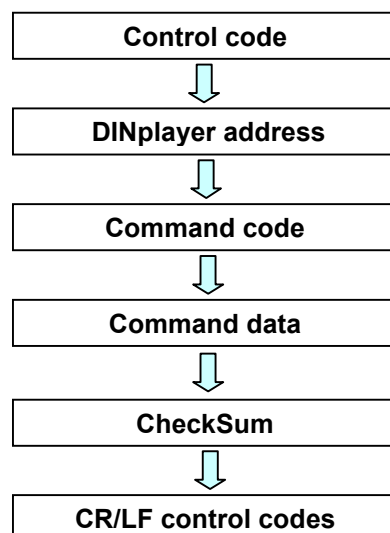

IMPORTANT:

the introduction of **CheckSum** at the end of the block of data and characters of **CR + LF** is defined in the configuration file.

8.10 Control codes

The control codes are characters (they belong to the first 32 ASCII characters and cannot be printed out) which define the kind of information contained in the pack following them. The control codes used are those which appear on the following table.

DINplayer initialises the transmission sequence when it receives the character **ENQ**.

Mnemonic	Code	Description
STX	02H	Start TeXt. Beginning of transmission of reply pack.
ETX	03H	End TeXt. End of reply pack.
ENQ	05H	EnQuiry. Beginning of pack addressed to DINplayer (or # for RS485).
ACK	06H	ACKnowledge. Beginning of reply pack: all OK!
LF	0AH	Line Feed. End of line code.
CR	0DH	Carriage Return.
NAK	15H	Not AcKnowledge. Beginning of pack with error code.

N.B. The codes are expressed in hexadecimal.

8.11 Address (ADD)

The address is a number that allows the system Master to establish communication with one of the various modules connected to the same serial line.

The value of this address is defined in DINplayer through a configuration file *config.txt*.



IMPORTANT:

- when setting the address it is necessary to be careful to not define more than one module with the same number, otherwise the communication becomes confused and irregular and the data exchanged will no longer make sense.
- The address can assume any value between **00H and 1FH**.
- The address is expressed in ASCII characters and consists of **2** characters.

Note! BROADCAST Commands (CMAD=00)

DINplayer processes commands received with a 00 address without providing a reply.

8.12 Command (CMD)

This is used to define the operation to be carried out (for example PLAY, reading the state or setting of the volume). The commands are defined in ASCII characters and consists of **2** characters.

In the following sections of this chapter, we provide the list of commands and every detail about each command.

8.13 CheckSum (CHK)

The CheckSum makes sure that the packs are complete and not corrupted during their transmission by any noise induced on the line.

The CheckSum is calculated summing the hexadecimal value of the ASCII characters contained in the data area defined for the CheckSum. The two least significant characters (in hexadecimal) of the sum represent the CheckSum which is introduced into the two dedicated ASCII characters at the end of the pack (before any CR and LF characters).

Note ! The sum of the value in decimal of the ASCII codes, converted into hexadecimal, must give the same result. Introduction and management of the CheckSum is established by the CMCK parameter of the configuration file.

- If **CMCK=1** has been set, CheckSum will be calculated automatically and added to the term of the reply pack (the one beginning with '**STX**') when this is delivered. When a pack is received, DINplayer calculates the new CheckSum and compares it with the one contained in the pack itself; if it agrees, DINplayer goes on to perform the command, otherwise it delivers an error pack (pack beginning with '**NAK**').
- If **CMCK=0** has been set, CheckSum will not be delivered in transmission and will not be compared (also because it is missing in the data) in the received messages. The following figure shows an example of calculation of CheckSum in a command pack delivered by the master.

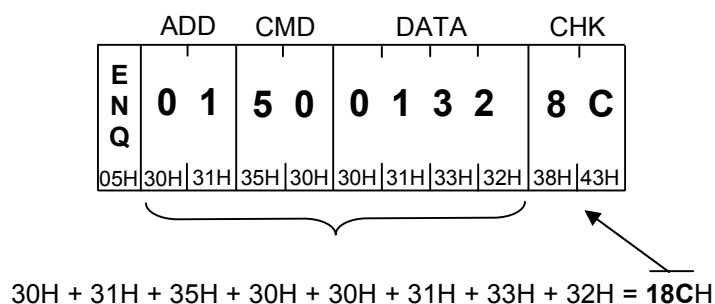

8.14 Basic protocol

Reading the data of the DINplayer from the master

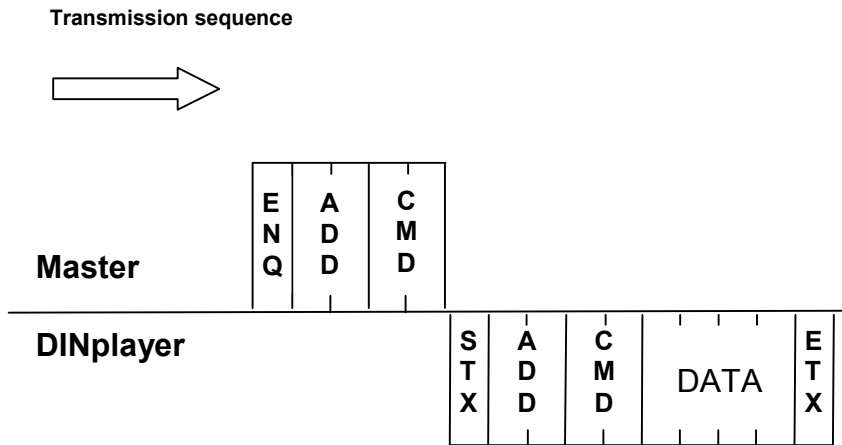

Command transmission from master to DINplayer

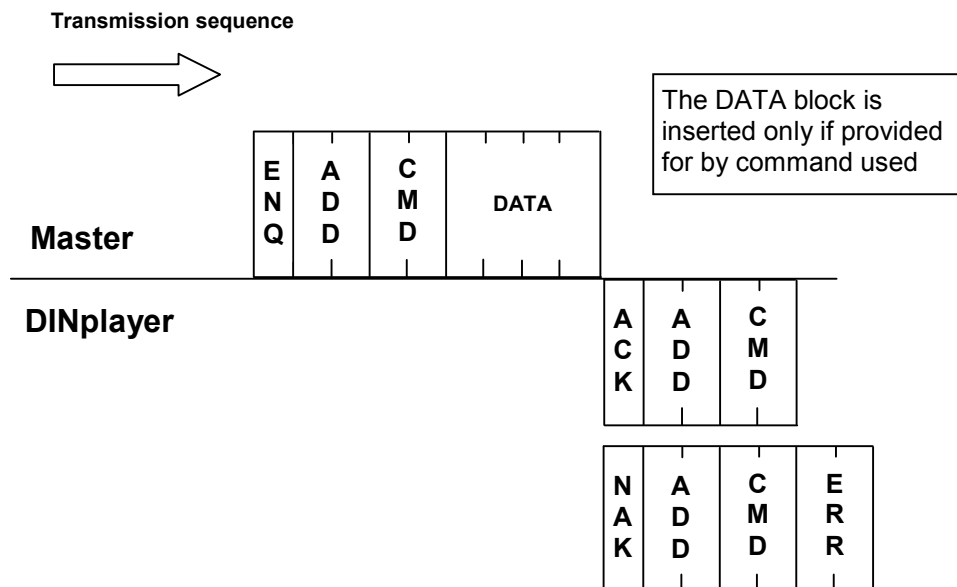

8.15 Basic protocol with CheckSum

Reading the data of the DINplayer from the master

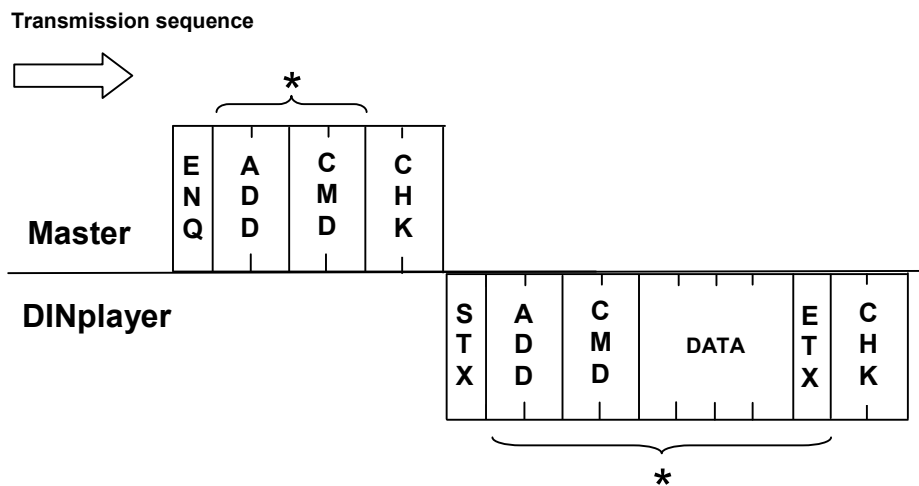

Command transmission from master to DINplayer

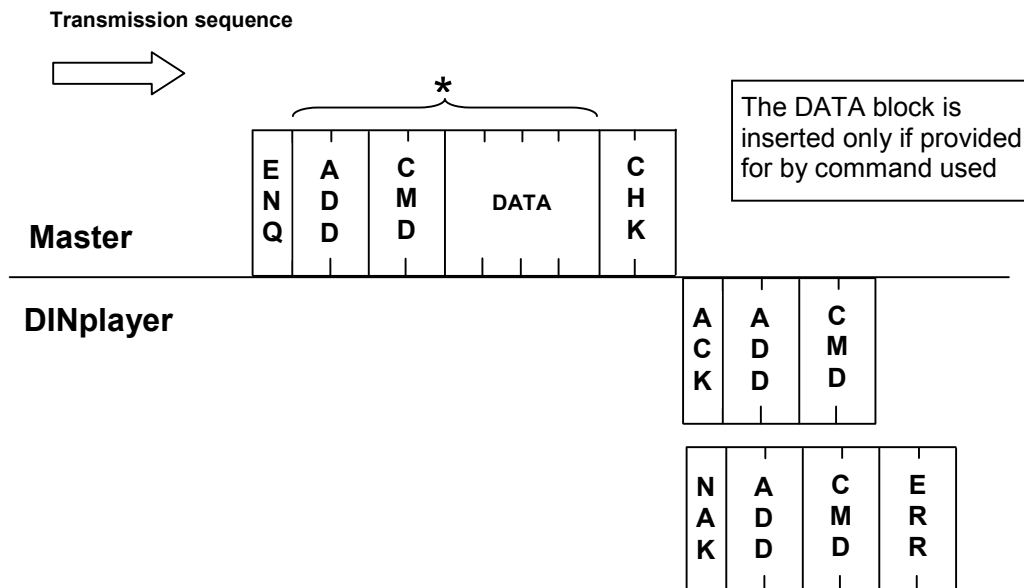

- * 1. The CheckSum is introduced if the configuration parameter CMCK=1.
 2. The CheckSum is calculated summing all the characters marked by an asterisk.

8.16 Basic protocol with CR and LF

Reading the data of the DINplayer from the master

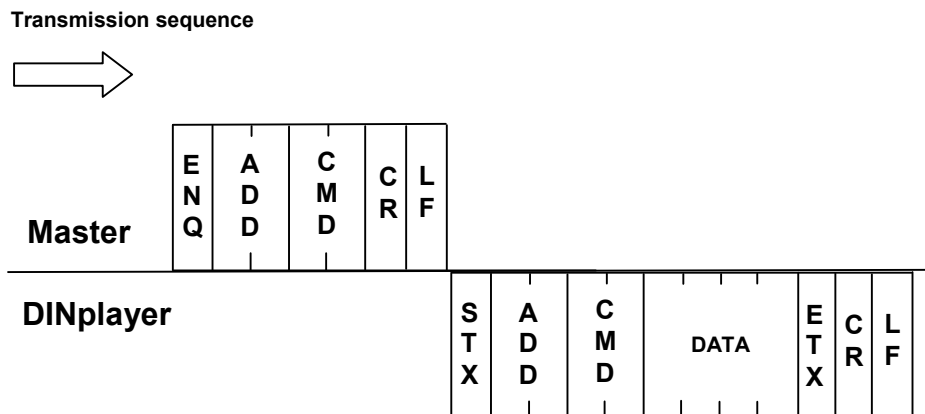

Command transmission from master to DINplayer

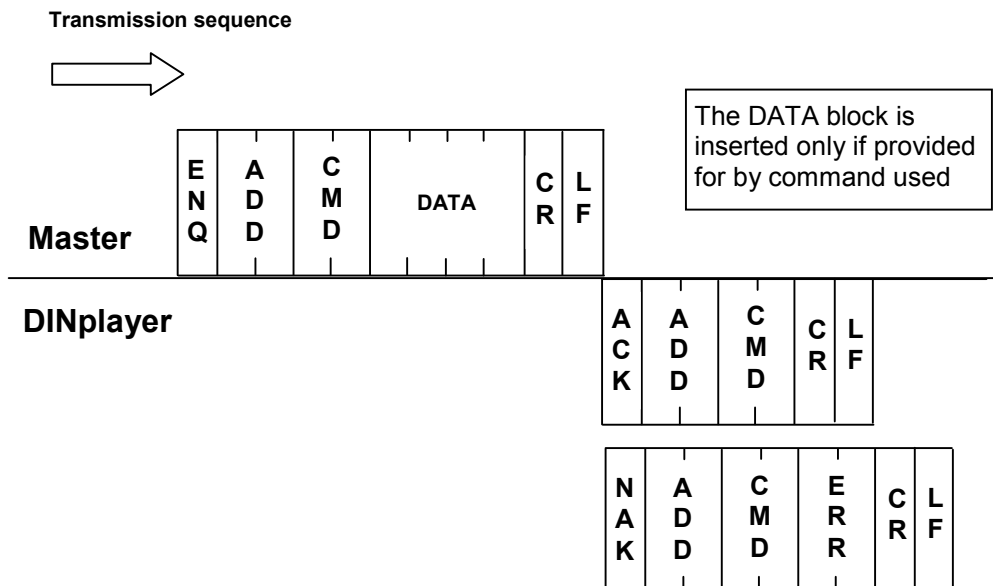

8.17 Basic protocol with CheckSum, CR and LF

Reading the data of the DINplayer from the master

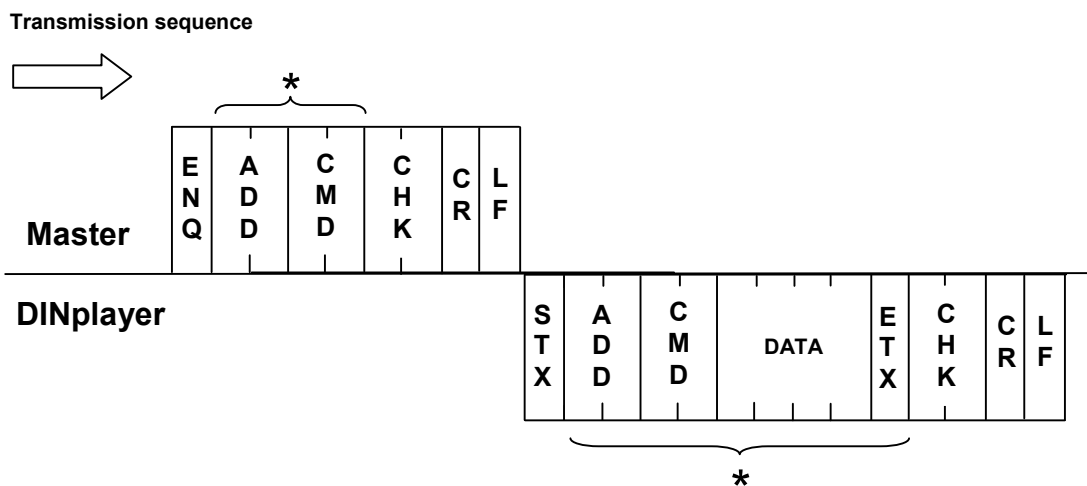

Command transmission from master to DINplayer

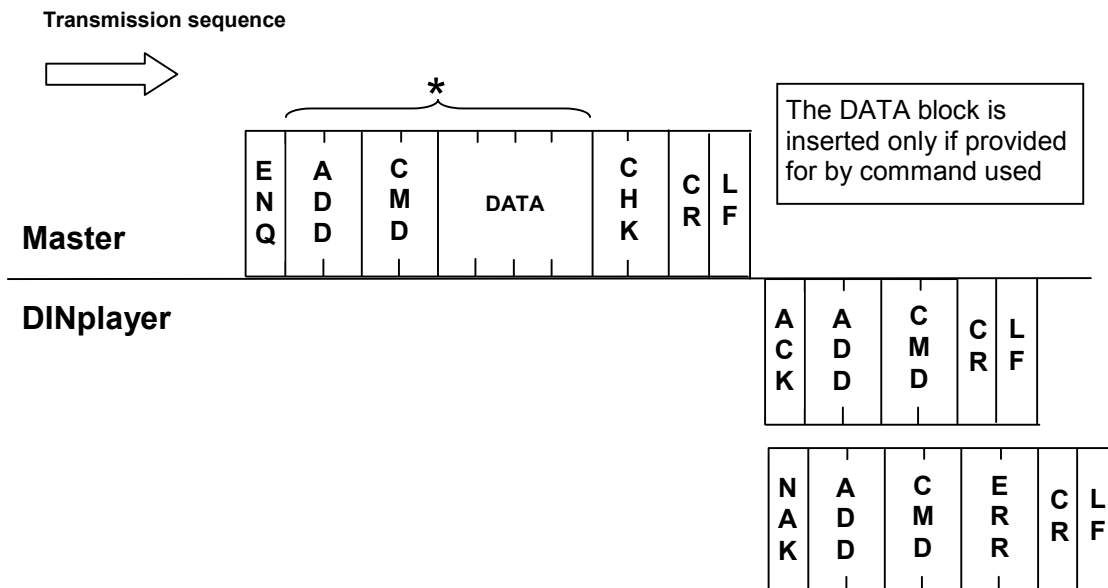

- * 1. The CheckSum is introduced if the configuration parameter CMCK=1.
 2. The CheckSum is calculated summing all the characters marked by an asterisk.

8.18 List of commands and operating fields

This table provides the list, with the relevant comments, of all the commands managed by DINplayer.

Description	CMD	Command data	Reply data
STATUS request	30	None	<i>a b c d</i> a = State of the player: S = Stop P = Play b = (reserved) c = (reserved) d = (reserved)
STOP	31	None	None
PLAY First	32	None	None
PLAY Next	33	None	None
PLAY Prior	34	None	None
PLAY File	50	Name of file without extension (4 characters only)	None
PLAY File 2 (automatic STOP before PLAY)	51	Name of file without extension (4 characters only)	None
SET Volume	52	Level in hexadecimal (0..14H)	None
SET Treble	53	Level in hexadecimal (0..14H)	None
SET Bass	54	Level in hexadecimal (0..14H)	None
SET Loudness	55	Level in hexadecimal (0..14H)	None
PLAY FileB	56	Name of file without extension (4 characters only)	None
PLAY File2B	57	Name of file without extension (4 characters only)	None
Version of firmware	35	None	P = DINplayer x = version xx = Release Version
State of inputs	37	None	<i>a b c d e f g h</i> a = 0 b = 0 c = IN 6 d = IN 5 e = IN 4 f = IN 3 g = IN 2 h = IN 1
Flash memory size	38	None	Size of the flash (MAX. 4 characters)
Title of item being played	39	None	Title of the item (MAX. 12 characters)



IMPORTANT: in order to manage any error messages correctly with the **PLAY File** (command code 50H) and **PLAY File 2** (command code 51H) commands, DINplayer will check for the requested MP3 file with a consequent delay of 800/900 mseconds whilst the reply is sent.

When using the **PLAY File B** (command code 56H) and **PLAY File 2 B** (command code 57H) commands, DINplayer will not check the memory and will immediately send an interpreted command message and the track will begin to play once the reply has been sent. The following errors are not managed with these commands: "File not found" (error code 32H) and "PLAY file failed" (error code 33H).

8.19 Error codes

The following table lists all the error codes which DINplayer delivers together with the **NAK** pack if problems are found.

Code	Description
10H	Failure to convert command code (CMD). It could contain characters which are outside the representation of a hexadecimal value. The permitted values are: 'a' .. 'f' 'A' 'F' '0'....'9'.
11H	Failure to convert the value contained in 'DATA' into a number. It could contain characters which are outside the representation of a hexadecimal value. The permitted values are: 'a' .. 'f' 'A' 'F' '0'....'9'.
12H	Failure to convert the CheckSum (CHK). It could contain characters which are outside the representation of a hexadecimal value. The permitted values are: 'a' .. 'f' 'A' 'F' '0'....'9'.
13H	Checksum wrong.
14H	Reserved error.
20H	Wrong value in the parameter of the command SET_Volume. It could be more than the maximum permitted value.
21H	Wrong value in the parameter of the command SET_Treble. It could be more than the maximum permitted value.
22H	Wrong value in the parameter of the command SET_Bass. It could be more than the maximum permitted value.
23H	Wrong value in the parameter of the command SET_Loudness. It could be more than the maximum permitted value.
30H	The command PLAY cannot be processed because the flash memory is missing.
31H	The command PLAY (excluding PLAY File 2) cannot be processed because DINplayer is already playing. To solve the problem, first send the command STOP, or else use the command PLAY_File_2 which automatically stops any file being played.
32H	The file requested via the command PLAY_File or PLAY_File_2 has not been found. The four characters inserted as an argument for these commands must correspond exactly to the name of the file you intend to play, except for the extension. E.g.: the command ENQ + 00501234 requires the playing of the file 1234.mp3 on DINplayer with address 00.
33H	Failure to play the requested file. The file could be corrupt.

9

SPECIFICATIONS**9.1 Technical features**

Power supply	: 12÷24VDC.
Consumption in standby	: 1 W
Protection	: inside fuse, 4A delayed.
Capacity of extractable memory :	SD/MMC from 32MB to 2GB.
Input absorption.....	: 5 mA
Formats accepted	: MPEG1 layer 3 (file MP3 from 64 to 192 Kbps)
Response in frequency	: 20 ~ 20.000 Hz (±3dB)
Signal/noise ratio	: > 90dB.
Harmonic distortion	: < 0,1%
Output power.....	: max. 20W (24V / 4 Ω) THD+N= 10%
Audio controls	: - General output volume control - Separate control of low and high tones - Loudness level control
Control keys	: 4 buttons REW, PLAY, STOP, FWD.
Classification.....	: IP 30 on the basis of liquid and dust penetration.
Size.....	: 90x53x59mm. / 2 DIN 43880 modules case hooking up to a DIN EN60715 guide
Weight.....	: 100 gr.

9.2 Obsolete devices disposal

- When you find this picture on a device, it means that the device is compliant with European Directive 2002/96/EC.
- All electronic and electric devices should be disposed separately from normal garbage.
- The proper disposal of old devices, accessories, and of the batteries in particular, it contributes to prevent possible negative consequences for human health and for the environment.
- For more detailed information on the disposal of obsolete devices, contact the municipality, the garbage disposal service or the shop in which the product has been acquired.

Manufactured by:  Noventa di Piave (VE) - ITALY



Product compliant with the safeguard regulations 2006/95/EC and 2004/108/EC about safety and electromagnetic compatibility.

COMMAND (CMAD=1, CMCK=0)	CMD	TO DINplayer		FROM DINplayer		NOTE 1	NOTE 2
		HEX	ASCII	HEX	ASCII		
STATUS REQUEST	30	05 30 31 33 30	ENQ 0130	02 30 31 33 30 53 4D 30 30 03 02 30 31 33 30 50 4D 30 30 03	STX 0130SM00 ETX STX 0130PM00 ETX	if in stop mode if in play mode	
STOP	31	05 30 31 33 31	ENQ 0131	06 30 31 33 31	ACK 0131		
PLAY FIRST	32	05 30 31 33 32	ENQ 0132	06 30 31 33 32 15 30 31 33 32 33 31	ACK 0132 NAK 013231	if in stop mode if in play mode (DINplayer doesn't perform the action)	
PLAY NEXT	33	05 30 31 33 33	ENQ 0133	06 30 31 33 33 15 30 31 33 33 33 31	ACK 0133 NAK 013331	if in stop mode if in play mode (DINplayer doesn't jump to the following file, it is first required to send a stop)	
PLAY PRIOR	34	05 30 31 33 34	ENQ 0134	06 30 31 33 34 15 30 31 33 34 33 31	ACK 0134 NAK 013431	if in stop mode if in play mode (DINplayer doesn't jump to the previous file, it is first required to send a stop)	
PLAY FILE song.mp3	50	05 30 31 35 30 73 6F 6E 67	ENQ 0150song	06 30 31 35 30 15 30 31 35 30 33 31	ACK 0150 NAK 015031	if in stop mode if in play mode (DINplayer doesn't perform the action, it is first required to send a stop)	
PLAY FILE fire.mp3	50	05 30 31 35 30 66 69 72 65	ENQ 0150fire	06 30 31 35 30 15 30 31 35 30 33 31	ACK 0150 NAK 015031	if in stop mode if in play mode (DINplayer doesn't perform the action, it is first required to send a stop)	
PLAY FILE 2 song.mp3 (automatic STOP before PLAY)	51	05 30 31 35 31 73 6F 6E 67	ENQ 0151song	06 30 31 35 31 06 30 31 35 31	ACK 0151 ACK 0151	if in play mode (DINplayer restarts from the beginning of the interrupted file) if in stop mode	
SET VOLUME (0 db - 14)	52	05 30 31 35 32 30 30 31 34	ENQ 01520014	06 30 31 35 32	ACK 0152		
SET VOLUME (-23 db - 4)	52	05 30 31 35 32 30 30 30 34	ENQ 01520004	06 30 31 35 32	ACK 0152		
SET VOLUME (off - 00)	52	05 30 31 35 32 30 30 30 30	ENQ 01520000	06 30 31 35 32	ACK 0152		
SET TREBLE (12 db - 20)	53	05 30 31 35 33 30 30 32 30	ENQ 01530020	06 30 31 35 33	ACK 0153		
SET BASS (12 db - 20)	54	05 30 31 35 34 30 30 32 30	ENQ 01540020	06 30 31 35 34	ACK 0154		
SET LOUDNESS(12 db-20)	55	05 30 31 35 35 30 30 32 30	ENQ 01550020	06 30 31 35 35	ACK 0155		
VERSION OF FIRMWARE	35	05 30 31 33 35	ENQ 0135	02 30 31 33 35 50 32 30 35 03	STX 0135P205 ETX		P = DINplayer x = version xx = Release
STATE OF INPUTS	37	05 30 31 33 37	ENQ 0137	02 30 31 33 37 30 30 30 30 30 30 30 30 03	STX 013700000000 ETX		a b c d e f g h a = 0 b = 0 c = IN 6 d = IN 5 e = IN 4 f = IN 3 g = IN 2 h = IN 1

COMAND (CMAD=1, CMCK=0)	CMD	TO DINplayer		FROM DINplayer		NOTE 1	NOTE 2
		HEX	ASCII	HEX	ASCII		
FLASH MEMORY SIZE	38	05 30 31 33 38	ENQ 0138	02 30 31 33 38 31 32 35 4D 03	STX 0138125M ETX		Size of the flash (MAX. 4 characters)
TITLE OF ITEM BEING PLAYED	39	05 30 31 33 39	ENQ 0139	15 30 31 33 39 33 36	NAK 013936	if in stop mode	File title (if present in ID3, 12 characters MAX; file name (8 characters truncated) if the title is not present.
				02 30 31 33 39 47 49 47 49 2E 4D 50 33 03	STX 0139SONG.MP3 ETX	If it is playing son.mp3	
				02 30 31 33 39 47 49 47 4F 2E 4D 50 33 03	STX 0139FIRE.MP3 ETX	If it is playing fire.mp3	
				02 30 31 33 39 43 41 4C 41 42 52 7E 31 2E 4D 50 33 03	STX 0139CALABR~1.MP3 ETX	If it is playing calabriacrotone.mp3	
STOP WITH CHECKSUM (CMCK=1)	31	05 30 31 33 31 43 35	ENQ 0131C5	06 30 31 33 31	ACK 0131		
STOP WITH CMCL=1 (without checksum)	31	05 30 31 33 31 0D 0A	ENQ 0131 CR LF	06 30 31 33 31 0D 0A	ACK 0131 CR LF		
STOP WITH CMDL=1 (without checksum)	31	05 30 31 33 31 0D 0A	ENQ 0131 CR LF	06 30 31 33 31 0D 0A	ACK 0131 CR LF		
STOP WITH CMCL=1 (with checksum)	31	05 30 31 33 31 43 35 0D 0A	ENQ 0131 CR LF	06 30 31 33 31 0D 0A	ACK 0131 CR LF		
STOP WITH CMCL=1 (with checksum)	31	05 30 31 33 31 43 35 0D 0A	ENQ 0131 CR LF	06 30 31 33 31 0D 0A	ACK 0131 CR LF		
STOP (CMAD=255 - FF)	31	05 46 46 33 31	ENQ 0131	06 46 46 33 31	ACK FF31		
STOP (CMAD=255 - FF)	31	05 46 46 33 31	ENQ 0131	06 46 46 33 31	ACK FF31		
STOP MULTICAST	31	05 00 00 33 31	ENQ 0131	no answer with multicast address			

Control characters:

- STX = 0x02
- ETX = 0x03
- ENQ = 0x05
- ACK = 0x06
- NAK = 0x015
- CR = 0x0D
- LF = 0x0A

 **IMPORTANT:**

- Address CMAD from 1 to 255 (0x01 – 0xff). Multicast address = 00 (0x00).
- If checksum is enabled (CMCK=1), DINplayer answers with the present checksum only if there is the data field.